

# Application of Rate Compatible Punctured Turbo Coded Hybrid ARQ to MC-CDMA Mobile Radio

Deepshikha Garg and Fumiyuki Adachi

MC-CDMA, a multicarrier (MC) modulation scheme based on code division multiple access (CDMA), is the most likely candidate for the next generation of mobile radio communications. The rate compatible punctured turbo (RCPT) coded hybrid automatic repeat request (HARQ) has been found to give improved throughput performance in a direct sequence (DS) CDMA system. However, the extent to which the RCPT HARQ improves the throughput performance of an MC-CDMA system has not been fully understood. In this paper, we apply the RCPT HARQ to MC-CDMA and evaluate by computer simulations its performance in a frequency selective Rayleigh fading channel. We found that the performance of RCPT HARQ MC-CDMA is almost insensitive to channel characteristics. The performance can be drastically improved with receive diversity combined with space-time transmit diversity. In addition, the comparison of RCPT HARQ MC-CDMA, orthogonal frequency division multiplexing, and DS-CDMA shows that under similar conditions the throughput of MC-CDMA is the best in a frequency selective fading channel.

**Keywords:** Hybrid automatic repeat request (HARQ), rate compatible punctured turbo codes, multicarrier (MC)-CDMA, mobile communication.

## I. Introduction

In broadband mobile radio communications, a transmitted signal is scattered by many obstacles located between a transmitter and a receiver, thereby creating a propagation channel with numerous paths having different time delays. The transfer function of such a broadband channel is no longer constant over the signal bandwidth and is referred to as a frequency-selective channel [1]. For successful communications in such wireless transmission channels, some powerful multi-access schemes and error-control techniques are necessary.

Recently, multicarrier code division multiple access (MC-CDMA), which is a combination of CDMA and multicarrier modulation based on orthogonal frequency division multiplexing (OFDM), has been attracting much attention [2] and is under extensive study. In MC-CDMA, each user's data-modulated symbol to be transmitted is spread over a number of subcarriers using an orthogonal spreading sequence defined in the frequency domain.

One of the most powerful error control techniques is a hybrid automatic repeat request (HARQ) with turbo codes. Turbo codes [3], introduced in 1993 by Berrou et al., have been intensively studied as the error correction code for mobile radio applications. In [4], the authors show that the throughput of the turbo coded HARQ scheme outperforms other ARQ schemes over fading and shadowing channels for direct sequence (DS) CDMA. The performance analysis of the rate compatible punctured turbo (RCPT) coded HARQ for DS-CDMA in a frequency-selective channel can be found in [5], [6], which show that the best performance is attained by the type II RCPT HARQ when a minimum amount of redundancy bits is transmitted with each retransmission. The RCPT HARQ performance in an OFDM system has been examined in [7].

Manuscript received Dec. 11, 2003; revised July 2, 2004.

Deepshikha Garg (phone: +81 22 217 7174, email: deep@mobile.ecei.tohoku.ac.jp) and Fumiyuki Adachi (email: adachi@ecei.tohoku.ac.jp) are with the Department of Electrical and Communications Engineering, Tohoku University, Sendai, Japan.

However, the extent to which the RCPT HARQ improves the throughput performance for MC-CDMA mobile radio has not been fully understood. In this paper, we apply the RCPT HARQ to MC-CDMA and evaluate by computer simulations its performance in a frequency-selective Rayleigh fading channel. The improvement in performance attainable in an MC-CDMA system with transmit and receive diversity is also evaluated and compared with that of OFDM and DS-CDMA.

The remainder of this paper is organized as follows. Section II reviews the RCPT HARQ schemes considered in this paper. The transmission system model using MC-CDMA is presented in section III. In section IV, we present and discuss the effects of various system and propagation parameters on the throughput performance of the RCPT HARQ for MC-CDMA and compare it with those of DS-CDMA and OFDM. Section V offers some conclusions.

## II. Review of RCPT HARQ Schemes

The various hybrid ARQ schemes considered in this paper are obtained from the rate 1/3 turbo code by puncturing it with different puncturing periods,  $P$  [5]-[7]. The turbo encoder/decoder parameters are shown in Table 1. A rate 1/3 turbo encoder, fed with an information bit sequence of length  $N$ , produces a systematic bit sequence (information bit sequence) and two parity bit sequences, all three with a length of  $N$ . The three sequences are punctured according to a puncturing pattern represented by a  $3 \times P$  matrix.

In the type I scheme, the two parity bit sequences are punctured according to the puncturing matrix using  $P=2$

$$\begin{bmatrix} 1 & 1 \\ 1 & 0 \\ 0 & 1 \end{bmatrix}$$

and transmitted along with the systematic bit sequence. If the receiver detects errors in the decoded sequence, a retransmission of that packet is requested. The retransmitted packet uses the same puncturing matrix as the previous packet. Since the previously transmitted packet is available at the receiver, time diversity

Table 1. Turbo encoder/decoder parameters.

Encoder	Rate	1/3
	Component encoder	(13,15) RSC
	Interleaver	S-random ( $S=K^{1/2}$ )
Decoder	Component decoder	Log-MAP
	Number of iterations	8

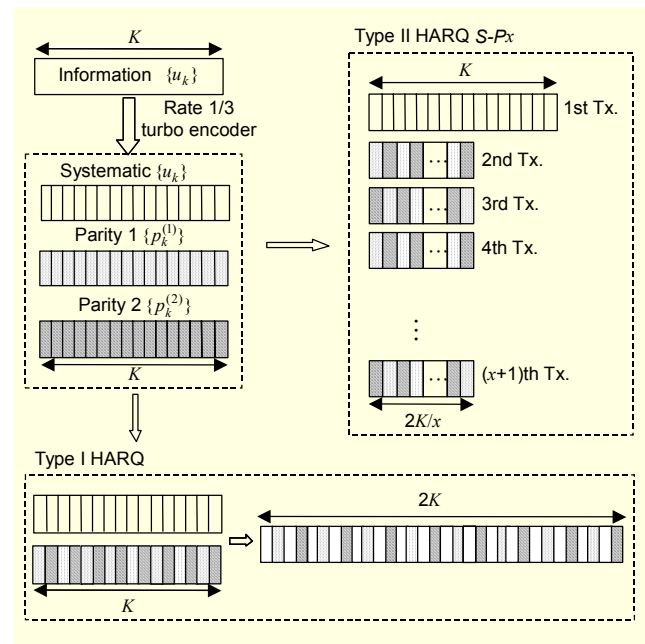

Fig. 1. Different HARQ schemes.

combining [8] is utilized.

In the type II hybrid ARQ, we consider three schemes represented by  $S-P_x$  (systematic-puncture period of  $P=x$ ) with  $x=2, 4$ , and  $8$ . The puncturing matrices for the first transmission to  $(x+1)$ th transmission are as follows:

Puncturing matrices for  $S-P_2$  (binary notation):

$$\begin{bmatrix} 1 & 1 \\ 0 & 0 \\ 0 & 0 \end{bmatrix} \begin{bmatrix} 0 & 0 \\ 1 & 0 \\ 0 & 1 \end{bmatrix} \begin{bmatrix} 0 & 0 \\ 0 & 1 \\ 1 & 0 \end{bmatrix}$$

Puncturing matrices for  $S-P_4$  (binary notation):

$$\begin{bmatrix} 1 & 1 & 1 & 1 \\ 0 & 0 & 0 & 0 \\ 0 & 0 & 0 & 0 \end{bmatrix} \begin{bmatrix} 0 & 0 & 0 & 0 \\ 1 & 0 & 0 & 0 \\ 0 & 0 & 0 & 1 \\ 0 & 0 & 1 & 0 \end{bmatrix} \begin{bmatrix} 0 & 0 & 0 & 0 \\ 0 & 0 & 1 & 0 \\ 0 & 1 & 0 & 0 \\ 1 & 0 & 0 & 0 \end{bmatrix} \begin{bmatrix} 0 & 0 & 0 & 0 \\ 0 & 0 & 0 & 1 \\ 0 & 1 & 0 & 0 \\ 0 & 0 & 1 & 0 \end{bmatrix}$$

Puncturing matrices for  $S-P_8$  (octal notation):

$$\begin{bmatrix} 3 & 7 & 7 \\ 0 & 0 & 0 \\ 0 & 0 & 0 \end{bmatrix} \begin{bmatrix} 0 & 0 & 0 \\ 2 & 0 & 0 \\ 0 & 1 & 0 \end{bmatrix} \begin{bmatrix} 0 & 0 & 0 \\ 0 & 2 & 0 \\ 0 & 0 & 4 \end{bmatrix} \begin{bmatrix} 0 & 0 & 0 \\ 0 & 0 & 1 \\ 0 & 0 & 1 \end{bmatrix} \begin{bmatrix} 0 & 0 & 0 \\ 0 & 0 & 4 \\ 0 & 1 & 0 \end{bmatrix}$$

The first transmission consists of transmitting only the

systematic bit sequence. The number of bits transmitted in the second transmission onwards differs depending on the puncturing period and is  $2N/x$ . As the number of retransmissions increases, the resultant code rate decreases. After each retransmission, turbo decoding is performed at the receiver. The presence of errors even after the  $(x+1)$ th transmission causes the sequences of systematic bits and punctured parity bits to be transmitted again in subsequent transmissions. In all the schemes, incremental redundancy [9] and time diversity combing are utilized.

### III. Transmission System Model

The transmission system model is shown in Fig. 2. We assume MC-CDMA with frequency domain spreading. We assume a single user case wherein all the available codes are assigned to the same user such that the data rate is the same as for OFDM. Such multicode MC-CDMA is applicable to both uplink and downlink transmission. At the transmitter a cyclic redundancy check (CRC) coded sequence is input to the RCPT encoder where it is turbo coded, punctured and stored in the buffer for possible retransmissions. The punctured sequences, which are of different lengths for different puncturing periods, are block-interleaved and data-modulated. The symbol sequence is serial-to-parallel (S/P) converted to  $SF$  symbol

streams, each stream further S/P converted to  $N_c/SF$  symbol streams, and each symbol in the  $N_c/SF$  streams copied  $SF$  times and multiplied by an orthogonal code. Here,  $SF$  is the spreading factor and  $N_c$  is the number of subcarriers. The  $SF$  code multiplied symbols are then added, multiplied by a long common pseudo-noise ( $pn$ ) sequence, and transmitted over the  $N_c$  subcarriers. This is done by applying the inverse fast Fourier transform (IFFT). After the insertion of a guard interval (GI), the MC-CDMA signal is transmitted over a frequency selective Rayleigh fading channel and is received by multiple antennas at the receiver. The MC-CDMA signal received on each antenna is decomposed into the  $N_c$  orthogonal subcarrier components by applying the fast Fourier transform (FFT). The frequency domain minimum mean square error (MMSE) equalization based on a subcarrier-by-subcarrier error minimization is carried out [10] and multiplied by the common  $pn$ -code. The  $N_c$  subcarrier components are then despread using the different orthogonal codes. For each code,  $N_c/SF$  symbols are obtained; a total of  $N_c$  symbols are received per MC-CDMA signaling interval. After parallel-to-serial (P/S) conversion, the soft decision sample sequence is de-interleaved and input into the RCPT decoder, which consists of a depuncturer, a buffer and a turbo-decoder. Error detection is performed by the CRC decoder which generates an ACK/NAK command and recovers the information sequence

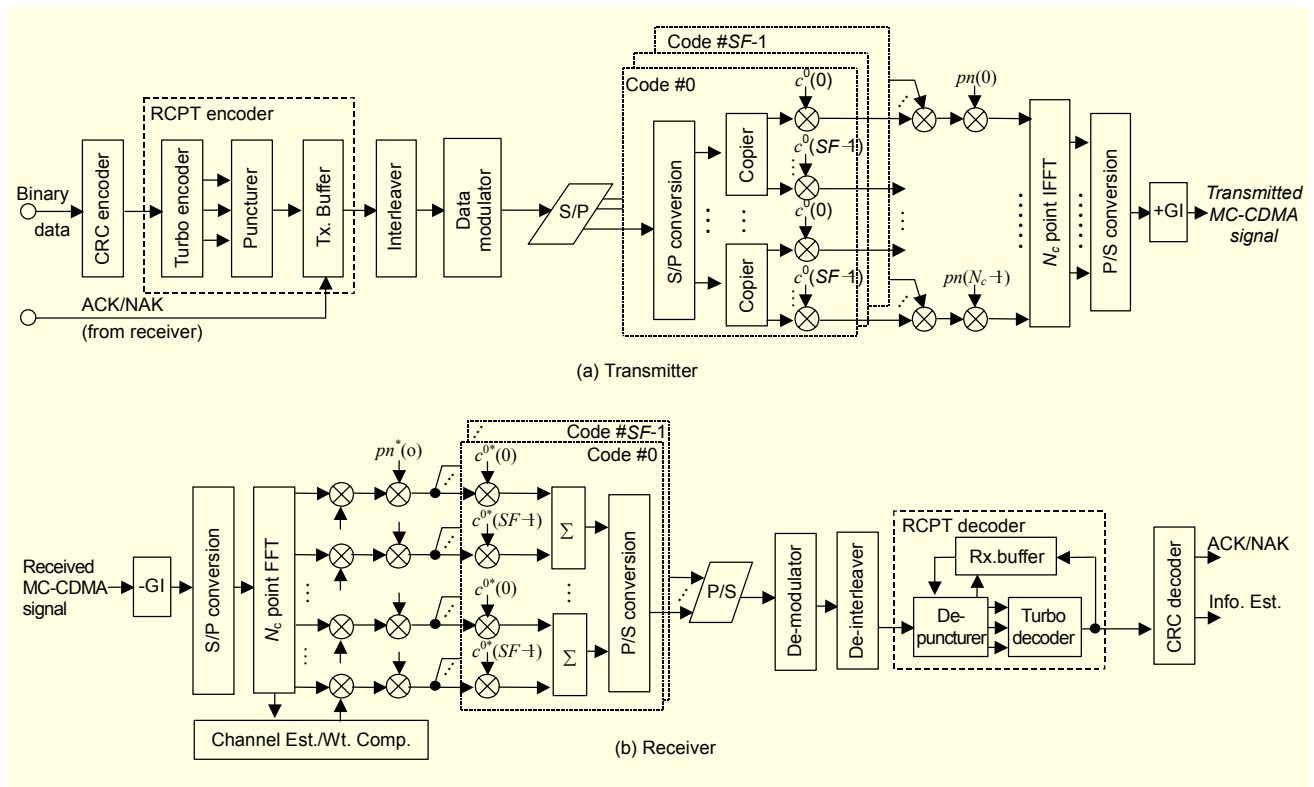

Fig. 2. Transmission system model.

in case no errors are detected.

When space-time transmit diversity (STTD) [11] is applied,  $2N_c$  symbols are transmitted over two MC-CDMA signaling intervals from the two transmit antennas. At the receiver, frequency domain MMSE equalization is jointly performed with STTD decoding [12].

#### IV. Simulation Results

The turbo encoder/decoder parameters are as shown in Table 1. The computer simulation conditions are summarized in Table 2.

The information sequence length,  $K$ , which represents the CRC encoded sequence length, is assumed to be 1,024 bits unless otherwise stated. The turbo encoded sequence is interleaved with a size  $2^a \times 2^b$  block-interleaver, where  $a$  and  $b$  are the maximum allowable integers for a given sequence size and are determined so that an interleaver as close as possible to a square interleaver can be obtained. Unless otherwise stated, coherent binary phase shift keying (BPSK) modulation and ideal channel estimation are assumed for data demodulation at the receiver. We assume MC-CDMA using  $N_c=256$  subcarriers with a carrier spacing of  $1/T_s$  ( $T_s$  represents the effective symbol length) and a guard interval of  $T_g=T_s/8$  (i.e.,  $N_g=32$ ). IFFT and FFT sampling period  $\Delta T$  is  $\Delta T=T_s/256$ . We assume that the number of multiplexed codes is the same as  $SF$ , and  $SF=256$  unless otherwise stated. We assume the downlink channel to be composed of  $L=16$  paths with the exponential power delay profile having a decay factor,  $\alpha$ , and a propagation time delay difference of  $\Delta T$  between the nearest two paths. Uncorrelated, slow Rayleigh faded paths are generated using

Dent's model [13]. When  $\alpha=0$ , the power delay profile is uniform having a normalized delay spread of  $\tau_{rms}/T_s=0.036$ . The normalized maximum Doppler frequency,  $f_D T=0.001$ , is assumed, where  $T=T_s+T_g$ .

For ARQ, we assume an error-free reverse channel and ideal error detection and take the number of retransmissions to be infinite. Throughput efficiency  $\eta$  is defined in [8] as

$$\eta = \frac{\text{Bits transmitted successfully}}{\text{Total number of bits transmitted}} \quad (1)$$

##### 1. Comparison of Various HARQ Schemes

Figures 3 and 4 plot the average number of transmissions and throughput as a function of the average received signal energy per coded bit-to-AWGN power spectrum density ratio,  $E_c/N_0$ , with puncturing period  $P$  as a parameter for  $\alpha=\infty$  dB (single path) and  $\alpha=0$  dB (uniform profile). For reference, the average number of transmissions and the throughput for a basic ARQ (where channel coding is not applied) are also plotted.

The existence of multiple paths tends to cause the channel gains of the different subcarriers to vary independently. This results in frequency diversity, but at the same time orthogonality among the spreading codes is partially destroyed. MMSE equalization can restore the orthogonality to a certain extent. We see from Fig. 3 that when  $\alpha$  changes from  $\infty$  dB to 0dB, the increase in the average number of transmissions is drastic when channel coding is not applied. This is due to the increase in random errors owing to the channel selectivity. However, the average number of transmissions changes only

Table 2. Simulation Conditions.

Information sequence length	$K = 2^{10}$ to $2^{14}$ bit	
Channel interleaver	Block interleaver	
Modulation/demodulation	Coherent BPSK	
MC-CDMA	No. of subcarriers	$N_c = 256$
	Subcarrier spacing	$1/T_s$
	Guard interval	$T_g = T_s/8$
	Spreading factor	$SF = 1$ to $256$
ARQ	Type	Basic, Type I, Type II
	Max. no. of tx.	$\infty$
Propagation channel	Data channel	$L = 16$ path Rayleigh fading $f_D T = 0.001$
	Feedback channel	Ideal

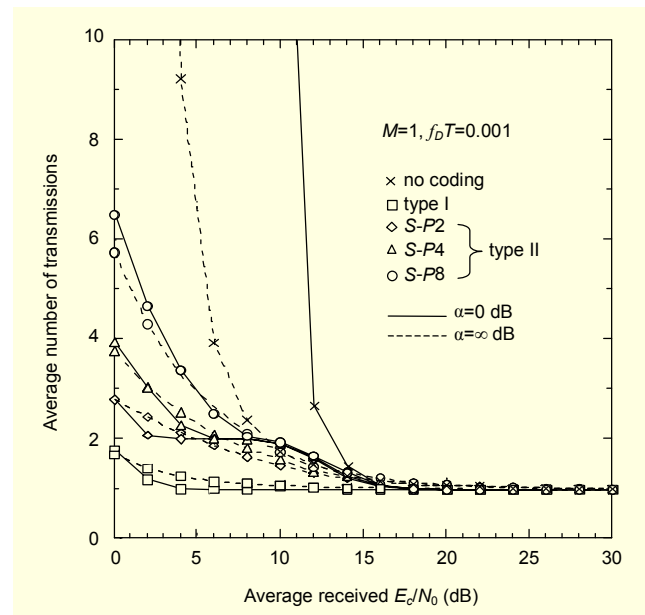

Fig. 3. Average no. of transmissions for different ARQ schemes.

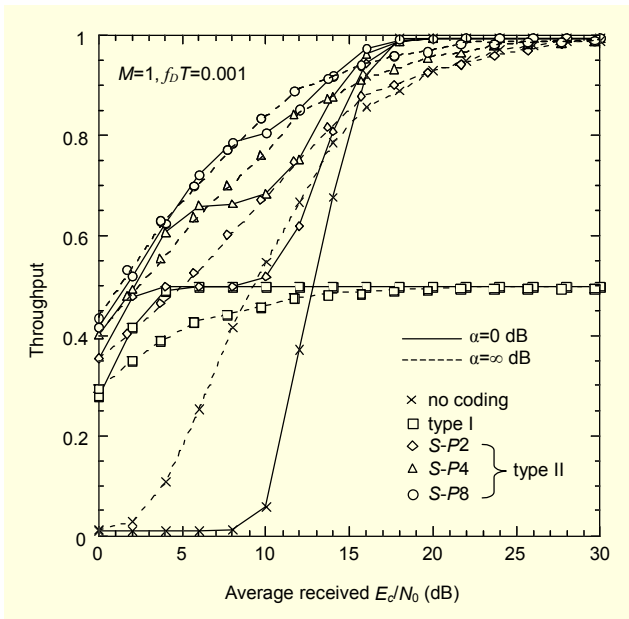

Fig. 4. Throughput for different ARQ schemes.

slightly when the RCPT HARQ is applied, as turbo codes are better suited to correct random errors. Among the RCPT HARQ schemes, the best throughput is attained with type II *S-P8*, as a minimum amount of parity bits is transmitted with each retransmission. Since the type II *S-P8* scheme was found to give the best throughput performance, it has been used to evaluate the impact of other system and propagation parameters.

### 2. Impact of Information Sequence Length

It is well known [3] that the turbo coding gain depends on the information sequence length ( $K$ ). The longer the information sequence length, the better the bit error rate (BER) performance as the internal interleaver size and the allowable size of the channel bit interleaver both increase. In the original paper on turbo coding by Berrou et al. [3], as well as in many of the subsequent papers, impressive results on BER performance have been presented for coding with very large information sequence lengths of the order of 65536 bits. On the other hand, since the probability of frame error can be generally reduced according to the decrease in transmitted sequence length, ARQ schemes are better suited for a shorter information sequence length. The throughput vs. information sequence length is plotted in Fig. 5 for various average received  $E_c/N_0$  values. We can see that the throughput is almost independent of the information sequence length.

### 3. Impact of Spreading Factor

In MC-CDMA, when the number of multiplexed codes,  $C$ ,

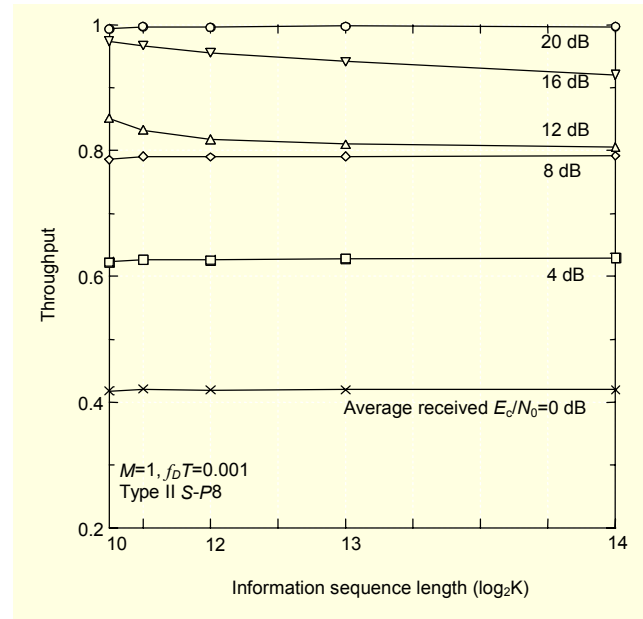

Fig. 5. Throughput for different information sequence lengths.

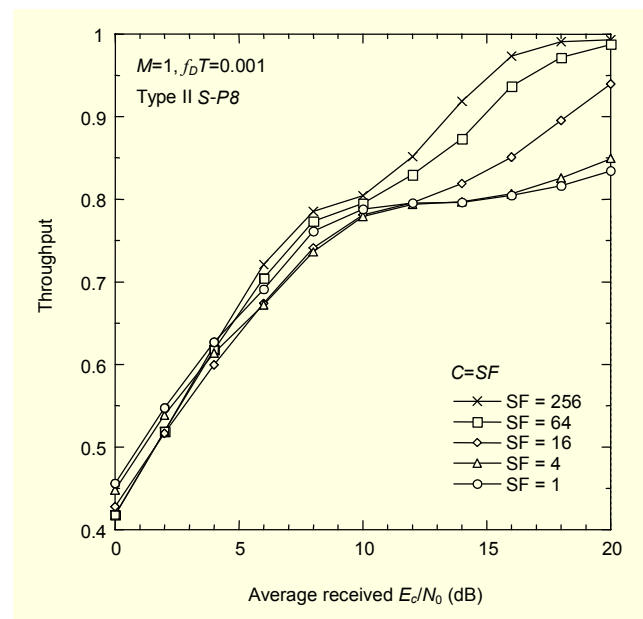

Fig. 6. Throughput for different spreading factors for  $C=SF$ .

is the same as the  $SF$ , the data rate remains constant and is the same as in OFDM, which can be seen as a special case of MC-CDMA with  $SF=1$ . With  $SF=N_c$ , each symbol is spread over all the available subcarriers, while each symbol is mapped onto a different subcarrier when  $SF=1$ . Figure 6 plots the throughput for the type II *S-P8* scheme as a function of the average received  $E_c/N_0$  with  $SF$  as a parameter for  $C=SF$ . We see that for a lower average received  $E_c/N_0$ , the throughput is almost independent of  $SF$ . However, for a higher  $E_c/N_0$ , the throughput increases with an increase in  $SF$ . A 20% increase in



throughput is seen for  $SF=256$  compared to  $SF=1$  when  $E_c/N_0=20$  dB. In a frequency selective channel, the channel gain is different for different subcarriers. In MC-CDMA, each symbol is spread over  $SF$  subcarriers and benefits from a larger frequency diversity gain when despreading; the frequency diversity effect is the largest when each data symbol is spread over all subcarriers  $SF=N_c$ .

#### 4. Impact of the Power Delay Profile Shape

The dependence of the RCPT HARQ throughput on the delay spread of the channel is discussed in this section. The delay spread is related to decay factor  $\alpha$ . Figure 7 plots the throughput as a function of the delay spread expressed in terms of  $\tau_{rms}/T_s$ . As  $\tau_{rms}/T_s$  increases, the selectivity of the channel strengthens. When  $SF=256$ , each symbol is spread over all the available subcarriers; the fading experienced by all the symbols in an MC-CDMA signaling interval is the same. However, when  $SF < N_c$ , the fading differs for the symbols in an MC-CDMA signaling interval. This results in more random errors as  $\tau_{rms}/T_s$  increases. Hence the throughput, which is prone to random errors, decreases for  $SF=16$  and  $1$  as the delay spread increases.

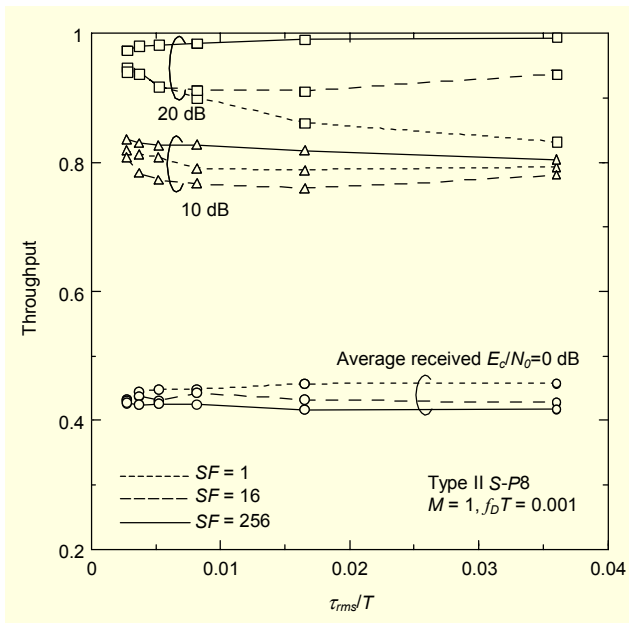

Fig. 7. Throughput for different delay spread  $\tau_{rms}/T$ .

#### 5. Impact of Modulation Level

The number of bits that can be transmitted with each transmission can be increased with the modulation level. With quaternary PSK (QPSK) and 16 quadrature amplitude modulation (16QAM), 2 and 4 bits can be transmitted over each symbol, respectively. The throughput in bps/Hz, defined as the ratio of the number of information bits transmitted

successfully to the total number of bits transmitted and multiplied with the transmission rate normalized by the bandwidth, is plotted in Fig. 8. We can see that with the increase in modulation level, the throughput increases. However, for lower  $E_c/N_0$  regions, QPSK provides a higher throughput than 16QAM. This is because the Euclidean distance between the symbols in the signal-space diagram reduces with the increase in the modulation level, which results in more decision errors in the noise dominant regions.

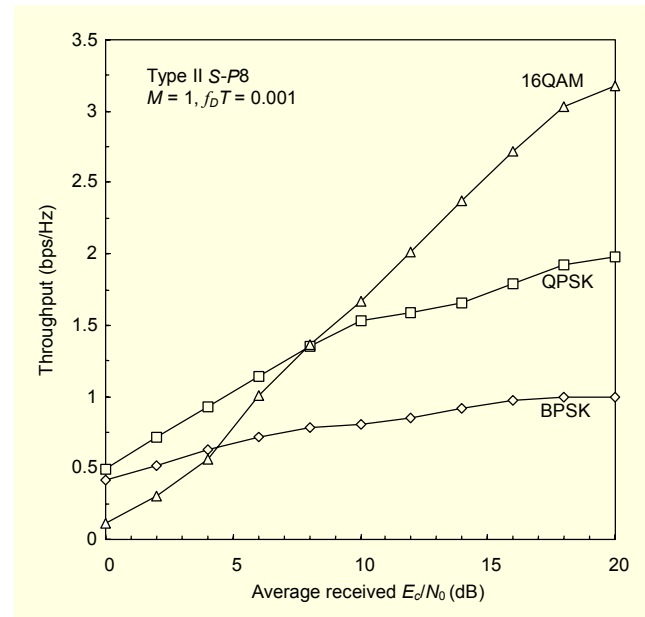

Fig. 8. Throughput for different modulation levels.

#### 6. Impact of Antenna Diversity

So far, we have considered a single antenna reception case. Recently, using multiple transmit/receive antennas has been looked upon as a desirable technique to improve throughput, i.e., data rate. We consider STTD with two transmit antennas and  $M$ -antenna receive diversity. Figure 9 plots the effect of using multiple antennas at the receiver. The throughput with a single transmit antenna and a single receive antenna is 0.72 at the average received  $E_c/N_0=6$  dB. Using two antennas at the receiver improves the throughput by about 14%. Using STTD with antenna diversity reception can further improve the performance by about 10% at  $E_c/N_0=6$  dB. Total improvement with STTD and two-antenna receive diversity is about 25% compared to that of no diversity. This shows that RCPT HARQ is effective when both STTD and antenna diversity are present.

#### 7. Comparison of MC-CDMA with OFDM and DS-CDMA

The performances of MC-CDMA, OFDM, and multicode DS-CDMA with RCPT HARQ are compared here. Two

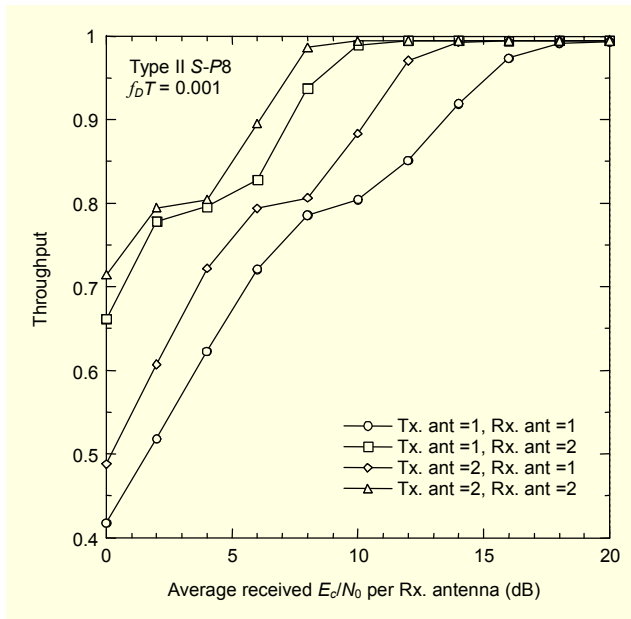

Fig. 9. Impact of antenna diversity.

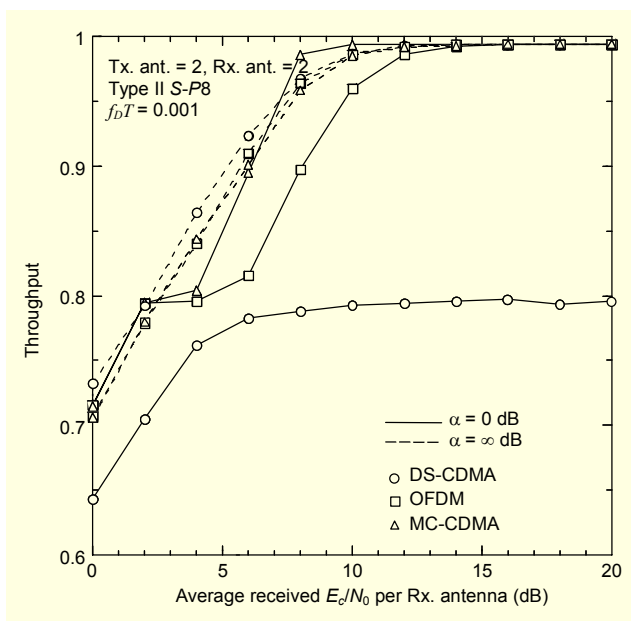

Fig. 10. Comparison of OFDM, DS-CDMA and MC-CDMA systems.

transmit antennas (STTD) and two receive antennas are assumed. For a fair comparison, we take the number of subcarriers ( $N_c$ ) in OFDM to be the same as in MC-CDMA. In addition, the spreading factor ( $SF$ ) in DS-CDMA is assumed to be the same as that in MC-CDMA, i.e.,  $SF=256$ . An  $SF$ -multicode DS-CDMA system is considered in order to get a data rate equal to that in the MC-CDMA system. Figure 10 plots the throughputs of MC-CDMA, OFDM, and DS-CDMA. The time delay separation between consecutive paths is 1 FFT

sample for the MC-CDMA/OFDM system and 1 spreading chip for the DS-CDMA system. An ideal coherent rake receiver is assumed for the DS-CDMA system. We can see that for  $\alpha=\infty$  dB (single path), the MC-CDMA/OFDM system has a slightly lower throughput than that of DS-CDMA because of the power penalty of the guard interval insertion. For  $\alpha=0$  dB (uniform profile), the performance of both OFDM and DS-CDMA degrades. But the performance of MC-CDMA remains unchanged. The existence of multiple paths distorts the orthogonality among the time domain spreading codes, which produces large intercode interference. Hence, the performance of multicode DS-CDMA is severely affected. The frequency selectivity also affects the OFDM system as packet errors increase with the increase in frequency selectivity. However, the MC-CDMA system is not affected because of frequency domain MMSE equalization.

## V. Conclusion

In this paper, RCPT HARQ was applied to MC-CDMA. We found that when channel coding is not used, the throughput decreases with the increase in channel selectivity. However, for a type II  $S$ -P8, the throughput is almost insensitive to channel selectivity when each symbol is spread over all the subcarriers available; spreading each symbol over all the subcarriers gives the highest throughput. We also found that the throughput is almost independent of the information sequence length. The performance can be improved by 25% when receive diversity is used together with space-time transmit diversity, as compared to the case of a single transmit and single receive antenna. In addition, the comparison of MC-CDMA, OFDM and DS-CDMA with RCPT HARQ shows that, under similar conditions, the throughput of MC-CDMA is best in a frequency selective fading channel.

## References

- [1] W.C. Jakes Jr., Ed., *Microwave Mobile Communications*, Wiley, New York, 1974.
- [2] S. Hara and R. Prasad, "Overview of Multicarrier CDMA," *IEEE Commun. Mag.*, Dec. 1997, pp. 126-144.
- [3] C. Berrou, A. Glavieux, and P. Thitimajshima, "Near Shannon Limit Error-Correcting Coding and Decoding-Turbo Codes," *Proc. Int'l Conf. Communications*, May 1993, pp. 1064-1070.
- [4] T. Ji and W.E. Stark, "Turbo-Coded ARQ Schemes for DS-CDMA Data Networks Over Fading and Shadowing Channels: Throughput, Delay and Energy Efficiency," *IEEE J.Select. Areas Commun.*, vol. 18, Aug. 2000, pp. 1355-1364.
- [5] D. Garg and F. Adachi, "Throughput of RCPT Hybrid ARQ for

DS-CDMA with Diversity Reception and Rake Combining,” *Proc. VTC03 Spring*, Korea, Apr. 2003, pp. 2730-2734.

- [6] D. Garg, R. Kimura, and F. Adachi, “Effect of Limited Number of Retransmissions of RCPT Hybrid ARQ for DS-CDMA Mobile Radio,” *Proc. WPMC02*, Hawaii, Oct. 2002, pp. 971-975.
- [7] D. Garg and F. Adachi, “Rate Compatible Punctured Turbo-Coded Hybrid ARQ for OFDM in a Frequency Selective Fading Channel,” *Proc. VTC03 Spring*, Korea, Apr. 2003, pp. 2725-2729.
- [8] F. Adachi and S. Itoh, “Efficient ARQ with Time Diversity Reception – a Time Diversity ARQ,” *Electronics Lett.*, vol. 22, Nov. 1986, pp. 1257-1258.
- [9] J. Hagenauer, “Rate-Compatible Punctured Convolutional Codes (RCPC codes) and Their Application,” *IEEE Trans. Commun.*, vol. 36, Apr. 1988, pp. 389-400.
- [10] F. Adachi and T. Sao, “Joint Antenna Diversity and Frequency-Domain Equalization for Multi-Rate MC-CDMA,” *IEICE Trans. Commun.*, vol. E86-B, no. 11, Nov. 2003, pp. 3217-3224.
- [11] S. Alamouti, “A Simple Transmit Diversity Technique for Wireless Communications,” *IEEE J. Select. Areas Commun.*, vol. 16, no. 8, Oct. 1998, pp. 1451-1458.
- [12] D. Garg and F. Adachi, “Joint Space-Time Transmit Diversity and Minimum MeanSquare Error Equalization for MC-CDMA with Antenna Diversity Reception,” *IEICE Trans. Commun.*, vol. E87-B, no. 4, Apr. 2004, pp. 849-857.
- [13] P. Dent, G.E. Bottomley, and T. Croft, “Jakes Fading Model Revisited,” *Electronics Lett.*, vol. 29, no. 13, June 1993, pp. 1162-1163.



**Deepshikha Garg** received the BE degree in electrical and communications engineering from Kathmandu University, Nepal in 1998. Currently she is in the PhD program in the Department of Electrical and Communications Engineering at Tohoku University, Sendai, Japan. Her research interests include error control schemes and accessing techniques for wireless communications. She was the recipient of the 2002 active research award in radio communication systems from IEICE in 2002 and the YRP young researcher award in 2003.



**Fumiyuki Adachi** received the BS and Dr. Eng. degrees in electrical engineering from Tohoku University, Sendai, Japan, in 1973 and 1984. In April 1973, he joined the Electrical Communications Laboratories of Nippon Telegraph & Telephone Corporation (now NTT) and conducted various types of research related to digital cellular mobile communications. From July 1992 to December 1999, he was with NTT Mobile Communications Network, Inc. (now NTT DoCoMo, Inc.), where he led a research group on wideband/broadband CDMA wireless access for IMT-2000 and beyond. Since January 2000, he has been with Tohoku University, Sendai, Japan, where he is a Professor of Electrical and Communication Engineering at the Graduate School of Engineering. His research interests are in CDMA and TDMA wireless access techniques, CDMA spreading code design, Rake receivers, transmit/receive antenna diversity, adaptive antenna arrays, bandwidth-efficient digital modulation, and channel coding, with particular application to broadband wireless communications systems. From October 1984 to September 1985, he was a United Kingdom SERC Visiting Research Fellow in the Department of Electrical Engineering and Electronics at Liverpool University. From April 1997 to March 2000, he was a visiting Professor at Nara Institute of Science and Technology, Japan. He was a recipient of the IEICE Achievement Award 2002 and was a co-recipient of the IEICE Transactions best paper of the year award in 1996 and again in 1998. He is an IEEE Fellow and was a co-recipient of the IEEE Vehicular Technology Transactions best paper of the year award in 1980 and again in 1990 and was also a recipient of the Avant Garde award in 2000.