

IBI Cancellation and Circular Property Loss Restoration for Broadband DS-CDMA Using FDE without CP Insertion

Min Zheng[†], Wei Peng[†] and Fumiyuki Adachi[‡]

Dept. of Electrical and Communication Engineering, Graduate School of Engineering, Tohoku University
6-6-05 Aza-Aoba, Aramaki, Aoba-ku, Sendai, 980-8579 Japan

E-mail: [†]min@mobile.ecei.tohoku.ac.jp, [†]peng@mobile.ecei.tohoku.ac.jp, [‡]adachi@ecei.tohoku.ac.jp

Abstract-In broadband DS-CDMA uplink transmission using frequency-domain equalization (FDE) without cyclic prefix (CP) insertion, the transmission performance degrades due to inter block interference (IBI) and circular property loss. In this paper, IBI cancellation and circular property loss restoration is proposed and the performance improvement is evaluated by computer simulation. It is shown that iterative IBI cancellation & circular property loss restoration can improve the BER performance in a frequency-selective Rayleigh fading channel. It is also shown that circular property loss restoration is more powerful than the IBI cancellation.

Keywords- DS-CDMA, MMSE-FDE, IBI cancellation, Circular property loss restoration

I. INTRODUCTION

In broadband direct sequence code division multiple access (DS-CDMA), one way to achieve the high-speed data transmission is to use orthogonal multi-code multiplexing [1]. However the wireless channel becomes very frequency selective [2] due to the multipath delay and as a result, the bit error rate (BER) performance of multi-code DS-CDMA degrades severely due to the frequency selective fading. An effective technique to improve the BER performance is the RAKE combining. However, as the chip rate increases, the frequency selectivity of the multipath channel becomes more severe due to the increasing number of resolvable paths. Therefore, minimum mean square error (MMSE) frequency domain equalization (FDE) [3] has been applied at the receiver instead of RAKE combining. It is proved [4] that MMSE-FDE outperforms RAKE combining.

Broadband DS-CDMA uplink transmission using FDE is a block transmission [5]. To avoid the inter block interference (IBI) [6], the cyclic prefix (CP) length must be longer than the maximum channel time delay. However, the insertion of CP decreases the bandwidth efficiency. Therefore, block transmission without CP has been considered to improve the bandwidth efficiency. The absence of CP produces IBI and the circular property loss. In this paper, the impacts of IBI and circular property loss on the transmission performance will be discussed. An iterative IBI cancellation and circular property loss restoration will be proposed.

The rest of this paper is organized as follows. Section II presents the system model of broadband DS-CDMA uplink transmission using FDE without CP. The impact of IBI and circular property loss on the bit error rate (BER) performance is discussed. In Section III, an iterative IBI cancellation and circular property loss restoration is proposed. The BER performance improvement by the iterative IBI cancellation and circular

property loss restoration is evaluated by computer simulation in Section IV. The paper will be concluded in Section V.

II. SYSTEM MODEL

In this study, DS-CDMA uplink transmission [7] is used and the system model is described in Section A. The reason of IBI and circular property loss is explained in Section B.

A. DS-CDMA uplink transmission

Figure 1 shows the system model of multi-code DS-CDMA transmission. At the transmitter side, after data modulation for the u -th ($u = 0 \sim U - 1$) data stream $d_u(t)$, the binary information sequence is spread by orthogonal spreading code $c_u(t)$ of spreading factor SF ($SF > U$). Then the sequence is multiplied by a scrambling sequence $c_{scr}(t)$ to generate the multi-code DS-CDMA data stream. At the receiver side, the signal is descrambled and de-spread after equalization. And the U parallel symbol streams are converted back to a sequence by a parallel/serial (P/S) converter before demodulation.

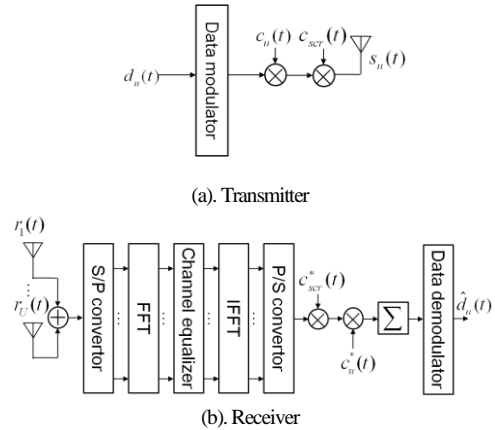

Fig.1 System model of the multi-code DS-CDMA

The multi-code DS-CDMA signal to be transmitted is expressed as

$$s(t) = \sqrt{\frac{2E_c}{T_c}} \sum_{u=0}^{U-1} d_u \left(\left\lfloor \frac{t}{SF} \right\rfloor \right) c_{scr}(t) c_u(t \bmod SF), \quad (1)$$

where E_c and T_c denote the chip energy and chip duration, respectively; SF is the spreading factor, u is the user index; d_u is the data sequence of user u ; $c_{scr}(t)$ is the channel-specific scrambling code; $c_u(t)$ is the user-specific spreading code; $\lfloor x \rfloor$ represents the largest integer less than or equal to x . The transmitted DS-CDMA signal propagates through a multi-path channel. At the receiver side, the base band equivalent received signal is given by

$$r(t) = \sum_{l=0}^{L-1} h_l s(t - \tau_l) + \eta(t), \quad (2)$$

where h_l is the l -th complex-valued path gain satisfying $\sum_{l=0}^{L-1} E[|h_l|^2] = 1$ ($E[\cdot]$ denotes the ensemble average operation). In this study, integer chip-spaced multi-path delay is used and $\tau_l = l$. $\eta(t)$ is a zero-mean complex-valued additive white Gaussian noise (AWGN) with a variance of $2N_0/T_c$, where N_0 is the single-side noise power spectrum density.

B. Inter-block interference and circular property loss

Figure 2 shows the effect of multi-path fading on the received signal. Suppose that data block # M is under detection. Due to the multi-path delay, data block # $M-1$ will “overlap” with data block # M . On the other hand, the circular property is lost due to the absence of received CP replica. In order to detect block # M , IBI should be removed and the circular property must be restored so that MMSE-FDE algorithm can be applied to the received block signal.

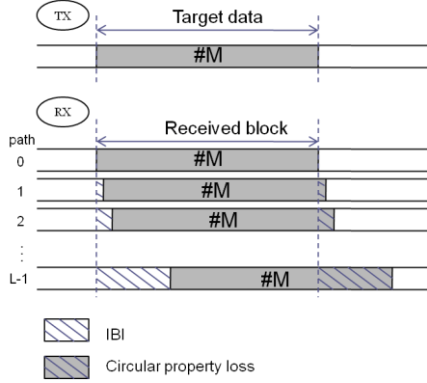

Fig.2 IBI and Circular property loss

III. PRINCIPLE OF IBI CANCELLATION AND CIRCULAR PROPERTY LOSS RESTORATION

The steps of the proposed MMSE FDE receiver with IBI cancellation and circular property loss restoration are shown in Figure 3. At first the IBI will be cancelled using the data decision of the previous block, then imperfect circular property loss restoration will be performed; in the next MMSE FDE will be applied to the data block after IBI cancellation and imperfect circular property loss restoration, an improved circular property loss restoration, can then be carried out by using the data decision after MMSE FDE. The performance of block detection can be improved in an iterative way until the termination condition is satisfied.

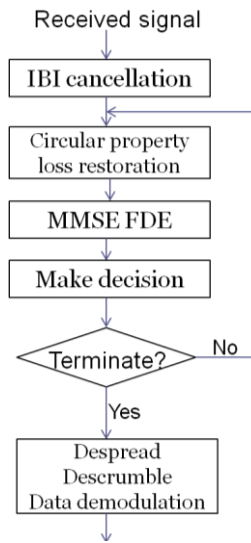

Fig. 3 Flow at receiver side

At the receiver side, the received DS-CDMA signal stream is divided into a sequence of N_c -chip blocks. The signal vector can be expressed using matrix form as

$$\begin{aligned} \mathbf{r} &= \mathbf{h}\mathbf{s}_0 + \mathbf{v} + \boldsymbol{\eta} \\ &= \mathbf{h}\mathbf{s}_0 + \mathbf{h}_{-1}(\mathbf{s}_{-1} - \mathbf{s}_0) + \boldsymbol{\eta} \\ &= \mathbf{h}\mathbf{s}_0 + \mathbf{h}_{-1}\mathbf{s}_{-1} - \mathbf{h}_{-1}\mathbf{s}_0 + \boldsymbol{\eta} \end{aligned} \quad (3)$$

In the right hand side of the Equation (3), the first term contains the desired signal, the second term contains the IBI and the third term contains the power loss. \mathbf{s}_0 , \mathbf{s}_{-1} and $\boldsymbol{\eta}$ are respectively $N_c \times 1$ vectors given as

$$\begin{cases} \mathbf{s}_0 = [s(0), s(1), \dots, s(N_c - 1)]^T \\ \mathbf{s}_{-1} = [s(-N_c), s(-N_c + 1), \dots, s(-1)]^T \\ \boldsymbol{\eta} = [\eta(0), \eta(1), \dots, \eta(N_c - 1)]^T \end{cases} \quad (4)$$

\mathbf{h} is the matrix of channel impulse response and \mathbf{h}_{-1} is the matrix of channel impulse response to cause the interference.

\mathbf{h}_{-1} can be given as

$$\mathbf{h}_{-1} = \begin{bmatrix} h_{L-1} & \cdots & h_1 \\ & \ddots & \vdots \\ \mathbf{0} & & h_{L-1} \end{bmatrix}_{N_c \times N_c}, \quad (5)$$

where, h_l is the complex valued path gain of the l th path.

Before giving the expressions for \mathbf{h} , we should notice that, since there is no CP, the circular property of \mathbf{h} is lost. Therefore, the IBI cancellation and circular property loss restoration must be performed to recover the circular property. According to Equation (3),

$$\begin{cases} \mathbf{v}_{-1} = \mathbf{h}_{-1}\mathbf{s}_{-1} \\ \mathbf{v}_0 = \mathbf{h}_{-1}\mathbf{s}_0 \end{cases}, \quad (6)$$

where, \mathbf{v}_{-1} is the IBI component, which should be cancelled; and \mathbf{v}_0 is the circular property loss component, which should be restored.

To solve these two problems, perfect IBI cancellation, perfect circular property loss restoration and imperfect restoration will be discussed and compared in the following.

A. Perfect IBI cancellation

To perform IBI cancellation, the estimation of the previous block # $M-1$ is required. The IBI component is reconstructed based on Equation (6) and then subtracted from the target block # M .

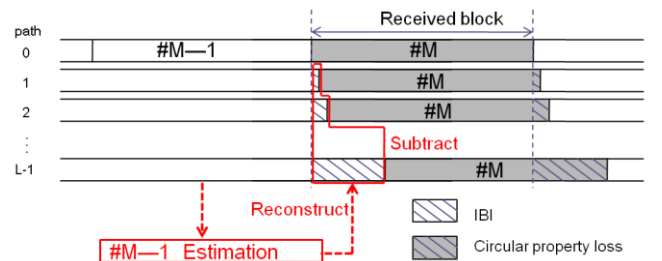

Fig. 4 Perfect IBI cancellation

To observe the effect of perfect IBI cancellation, \mathbf{s}_{-1} , which is the previous block signal, is assumed to be perfectly restored. The channel estimation is also assumed to be perfect. Therefore, the IBI component can be perfectly cancelled by using \mathbf{h}_{-1} and \mathbf{s}_{-1} .

B. Perfect circular property loss restoration

It can be seen from Figure 5 that, to perform circular property loss restoration, the estimation for the target block #M is required. The power loss component is reconstructed based on Equation (6) and then added to the head of the target block #M.

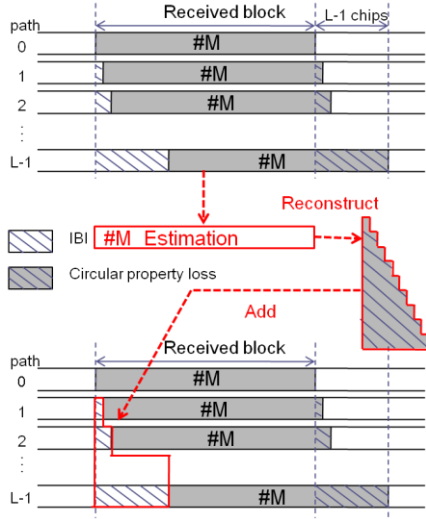

Fig. 5 Perfect circular property loss restoration

Similarly, perfect \mathbf{s}_0 and \mathbf{h}_{-1} will be used to observe the effect of perfect circular property loss restoration.

C. Imperfect circular property loss restoration [8]

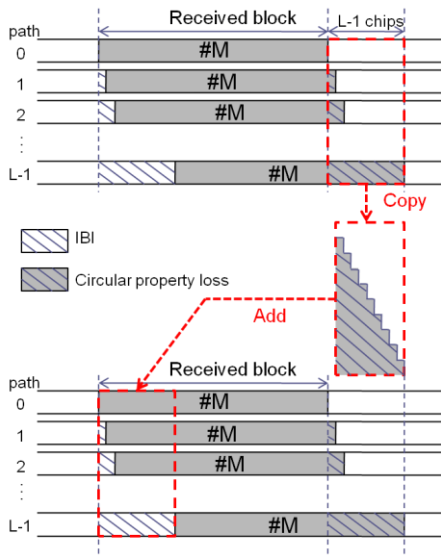

Fig. 6 Imperfect circular property loss restoration

Perfect \mathbf{s}_0 is used in Section B for perfect circular property loss. However, \mathbf{s}_0 is the target signal to be detected. In real case,

it is unknown during the processing procedure. Therefore a scheme of imperfect circular property loss restoration is proposed, which will simply copy the head of the next block and add to the head of the target block, as shown in Figure 6.

After the IBI cancellation and circular property loss restoration, the circular property of the channel matrix \mathbf{h} is recovered. The expression can be taken as a circular matrix,

$$\mathbf{h} = \begin{bmatrix} h_0 & & & h_{L-1} & \cdots & h_1 \\ \vdots & \ddots & & & & \vdots \\ h_{L-2} & \vdots & h_0 & \mathbf{0} & & h_{L-1} \\ h_{L-1} & \vdots & \vdots & h_0 & & \\ & \ddots & \vdots & \vdots & \ddots & \\ \mathbf{0} & & h_{L-1} & h_{L-2} & \cdots & h_0 \end{bmatrix}_{N_c \times N_c} \quad (7)$$

Therefore, the received signal can be given as

$$\mathbf{r} = \mathbf{h}\mathbf{s}_0 + \boldsymbol{\eta}, \quad (8)$$

MMSE-FDE is performed after the interference cancellation. The FDE is to apply N_c -point fast Fourier transform (FFT) to the signals. Frequency domain components are then equalized by weight $\{W(k)\}$, $k = 0 \sim N_c - 1$, shown in Figure 7.

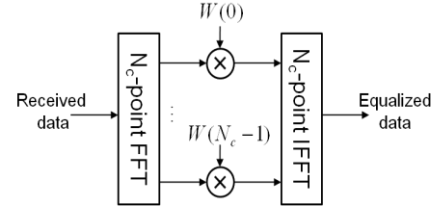

Fig.7 Frequency domain equalizer

By N_c -point FFT, the received signal \mathbf{r} is transformed into the frequency domain signal $\mathbf{R} = [R(0), R(1), \dots, R(N_c - 1)]$, which can be given by

$$\mathbf{R} = \mathbf{F} \cdot \mathbf{r} = \mathbf{H}(\mathbf{F}\mathbf{s}_0) + \mathbf{F}\boldsymbol{\eta}, \quad (9)$$

where $\mathbf{H} = \mathbf{F}\mathbf{h}\mathbf{F}^H$, \mathbf{F} is the $N_c \times N_c$ FFT matrix given as

$$\mathbf{F} = \frac{1}{\sqrt{N_c}} \begin{bmatrix} 1 & 1 & \cdots & 1 \\ e^{-j2\pi \frac{1 \cdot 1}{N_c}} & e^{-j2\pi \frac{1 \cdot 2}{N_c}} & \cdots & e^{-j2\pi \frac{1 \cdot (N_c-1)}{N_c}} \\ \vdots & \vdots & \ddots & \vdots \\ 1 & e^{-j2\pi \frac{(N_c-1) \cdot 1}{N_c}} & \cdots & e^{-j2\pi \frac{(N_c-1) \cdot (N_c-1)}{N_c}} \end{bmatrix}_{N_c \times N_c} \quad (10)$$

Since \mathbf{h} is a circular matrix, \mathbf{H} becomes a diagonal matrix denoted as

$$\mathbf{H} = \text{diag} [H(0), \dots, H(k), \dots, H(N_c - 1)], \quad (11)$$

where

$$H(k) = \sum_{l=0}^{L-1} h_l \exp\left(-j2\pi k \frac{\tau_l}{N_c}\right). \quad (12)$$

Then MMSE-FDE is applied to \mathbf{R} so that $\hat{\mathbf{R}} = \mathbf{W} \cdot \mathbf{R}$, where \mathbf{W} is the MMSE-FDE weight matrix. $\hat{\mathbf{R}}$ is given as

$$\hat{\mathbf{R}} = \mathbf{W}\mathbf{H}(\mathbf{F}\mathbf{s}_0) + \mathbf{W}\mathbf{F}\boldsymbol{\eta}. \quad (13)$$

According to the Wiener theory, for the given \mathbf{h} , \mathbf{W} can be obtained as

$$\mathbf{W} = \mathbf{H}^H \left\{ \mathbf{H}\mathbf{H}^H + \left(U \frac{E_c}{N_0} \right)^{-1} \mathbf{I} \right\}^{-1}. \quad (14)$$

The right side of Equation (14) is a diagonal matrix, so \mathbf{W} can also be expressed by a diagonal matrix as $\mathbf{W} = \text{diag}[W(0), \dots, W(k), \dots, W(N_c - 1)]$, resulting in one-tap MMSE-FDE. $W(k)$ is given by

$$W(k) = \frac{H^*(k)}{|H(k)|^2 + \left(U \frac{E_c}{N_0} \right)^{-1}}, \quad (15)$$

The frequency-domain signal $\hat{\mathbf{R}}$ after MMSE-FDE is transformed by an N_c -point inverse FFT (IFFT) back to the time-domain signal block as $\hat{\mathbf{r}} = \mathbf{F}^H \hat{\mathbf{R}}$. $\hat{\mathbf{r}}$ can be expressed as

$$\hat{\mathbf{r}} = \left(\frac{1}{N_c} \text{tr}[\mathbf{W}\mathbf{H}] \right) \mathbf{s}_0 + \hat{\boldsymbol{\mu}} + \hat{\boldsymbol{\eta}}, \quad (16)$$

where the first term is the desired signal and, $\hat{\boldsymbol{\mu}}$, $\hat{\boldsymbol{\eta}}$ are the residual inter-chip interference (ICI) and noise component, respectively. $\hat{\boldsymbol{\mu}}$ and $\hat{\boldsymbol{\eta}}$ can be expressed as

$$\begin{cases} \hat{\boldsymbol{\mu}} = \left\{ \mathbf{F}^H (\mathbf{W}\mathbf{H})\mathbf{F} - \left(\frac{1}{N_c} \text{tr}[\mathbf{W}\mathbf{H}] \right) \mathbf{I} \right\} \mathbf{s}_0 \\ \hat{\boldsymbol{\eta}} = -\mathbf{F}^H (\mathbf{W}\mathbf{F}) \boldsymbol{\eta} \end{cases}. \quad (17)$$

Finally, the signal is despread, descrambled and decoded.

IV. SIMULATION RESULTS

A. Simulation parameters

In this section, the performance of IBI cancellation and circular property loss restoration will be evaluated. The simulation parameters used are shown in Table 1. QPSK transmission is assumed and the propagation channel is assumed to be a frequency-selective block Rayleigh fading channel, which means the channel remains unchanged during a block. The channel has a chip-spaced 16-path uniform power profile. Ideal channel estimation is assumed. One user is considered and multi-user case, namely multi-user interference cancellation, will be considered in our future work.

Table 1 Simulation parameters

Transmitter	Data modulation	QPSK
	Spreading sequence	Product of Walsh sequence and Long PN sequence
	Spreading factor	SF=2, 4
	Number of user	Single user
Channel model	Type	Frequency selective block Rayleigh fading
	Number of path	L=16-path
	Decay factor	0dB
	Delay time	Chip-spaced
Receiver	Equalization	MMSE FDE
	Channel estimation	Ideal
	FFT size	Nc=256

B. Average BER performance comparison

Figure 8 shows the average bit error rate (BER) performance as a function of E_b/N_0 using IBI cancellation with/without perfect/imperfect circular property loss restoration under the condition SF=2 and SF=4, respectively. (Here, the circular property loss is short as CPL in figures.)

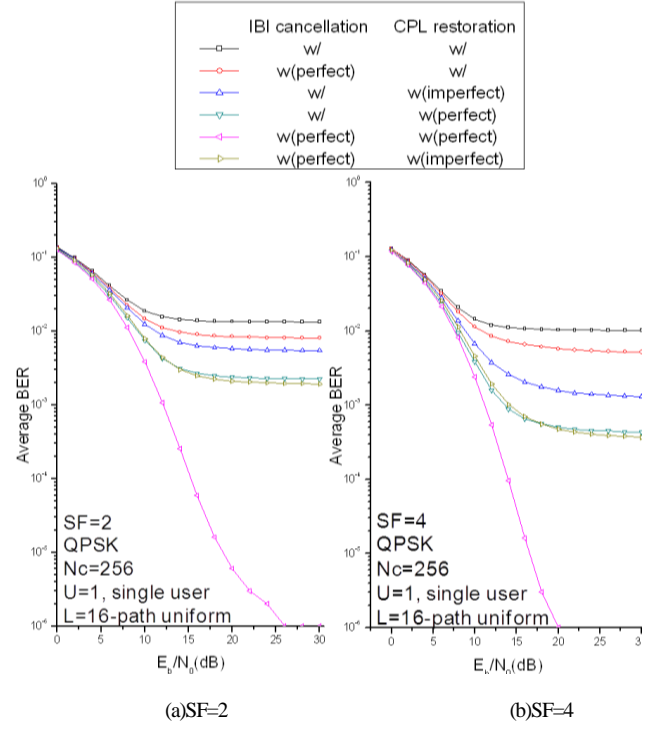

Fig. 8 Average BER performance comparison

From Figure 8, it is observed that circular property loss restoration is more effective than IBI cancellation. Even if imperfect circular property loss restoration is used, the performance improvement is more significant than the IBI cancellation. Although the error floor exits, imperfect circular property loss restoration can reduce the average BER to 5.4×10^{-3} -level, while the value is 8.0×10^{-3} using perfect IBI cancellation in the case SF=2. Even the performance can be improved to 2.2×10^{-3} if the CP is reconstructed ideally. If IBI

cancellation and circular property loss restoration are both applied, the error floor can be cleared up. In other word, the performance is only affected by the power of the noise, namely E_b / N_0 . The BER curve falls down to a quite low level (below 10^{-6}) when E_b / N_0 is over 30dB. If imperfect CPL restoration is combined with perfect IBI cancellation, a similar performance to the perfect circular property loss restoration case can be achieved. This indicates that we can apply the simple imperfect circular property loss restoration together with the IBI cancellation to achieve a close result to the perfect circular property loss restoration.

C. Distribution of symbol error rate of various strategies

The symbol error rate versus the symbol index is presented in Figure 9, which shows the distribution of error within an FFT block after equalization. $E_b / N_0 = 20dB$ is assumed.

Figure 9(a) shows the effect of IBI and circular property loss without any processing as a reference. When only perfect IBI cancellation is performed, it can be observed from Figure 9(b) that the significant errors at the head of the block are effectively improved. On the other hand, when only perfect circular property loss restoration is performed, it can be observed from Figure 9(c) that the symbol error rate at both the ends of the block can be improved. Compared with Figure 9(b), it seems worse than IBI cancellation. However, the error at the head (10^{-3} -level) is much smaller than that at the tail (10^{-1} -level), which makes the dominant effect on the average BER. Finally, the error distribution by using both perfect schemes is shown in Figure 9(d). It can be observed that the significant errors in both ends have been cleaned and the performance is the same as the case where CP is used.

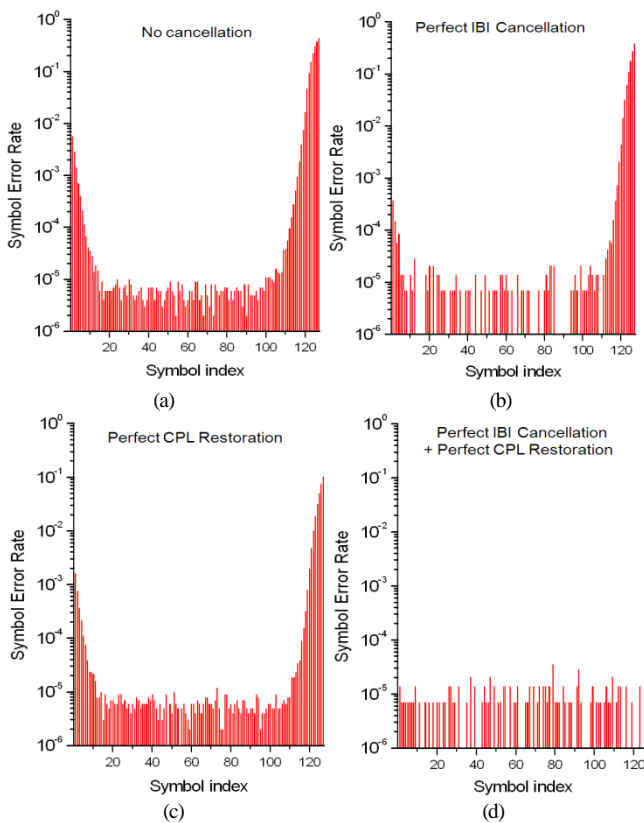

Fig. 9 Distribution of symbol error rate

V. CONCLUSION

In this paper, the MMSE-FDE receiver is considered for broadband DS-CDMA uplink transmission using FDE without CP insertion. The impact of IBI and circular property loss on the BER performance was discussed. An iterative IBI cancellation and circular property loss restoration was proposed. The BER performance with the proposed iterative IBI cancellation and circular property loss restoration was evaluated by computer simulation. It was shown that iterative IBI cancellation and circular property loss and circular property loss restoration can improve the BER performance in a frequency-selective Rayleigh fading channel. It was also shown that circular property loss restoration is more powerful than the IBI cancellation.

REFERENCES

- [1] F. Adachi, K. Ohno, A. Higashi and Y. Okumura, "Coherent multicode DS-CDMA mobile radio access," *IEICE Trans. Commun.*, E79-13, pp. 1316-1325, 1996.
- [2] J. G. Proakis, *Digital Communications*, fourth edition, New York: McGraw Hill, 2001.
- [3] D. Falconer, S. L. Ariyavisitakul, A. Benyamin-Seeyar, and B. Edison, "Frequency domain equalization for single-broadband wireless systems," *IEEE Commun. Mag.*, vol.40, no. 40, pp. 58-66, April 2002.
- [4] F. Adachi, T. Sao, and T. Itagaki, "Performance of multicode DS-CDMA using frequency domain equalization in a frequency selective fading channel," *IEE Electronics Letters*, vol. 39, no. 2, pp. 239-241, Jan. 2003.
- [5] M. K. Simon, J. K. Omura, R. A. Scholtz, and B. K. Levitt, *Spread Spectrum Communications Handbook*, New York: McGraw Hill, 1985.
- [6] A. Scaglione, G. Giannakis and S. Barbarossa, "Redundant filter bank precoders and equalizers Part I: Unification and optimal designs," *IEEE Trans. Signal Processing*, vol. 47, no. 7, pp.1988-2006, July 1999.
- [7] T. Obara, K. Takeda, K. Lee and F. Adachi, "Performance comparison of overlap FDE and sliding-window chip equalization for multi-code DS-CDMA in a frequency-selective fading channel," *IEICE Trans. Commun.*, vol.E94-B, no.3, March 2011.
- [8] Hankil Lee, Yusung Lee, and Hyuncheol Park, "An Efficient CP Compensation for SC-FDE with Insufficient CP Symbols", *IEEE Communications Letters*, vol. 14, no. 6, June 2010.